



Eve Double Pro-line FR

Manual / Manuel

Pro-line FR



OUTSIDE / EXTÉRIEUR

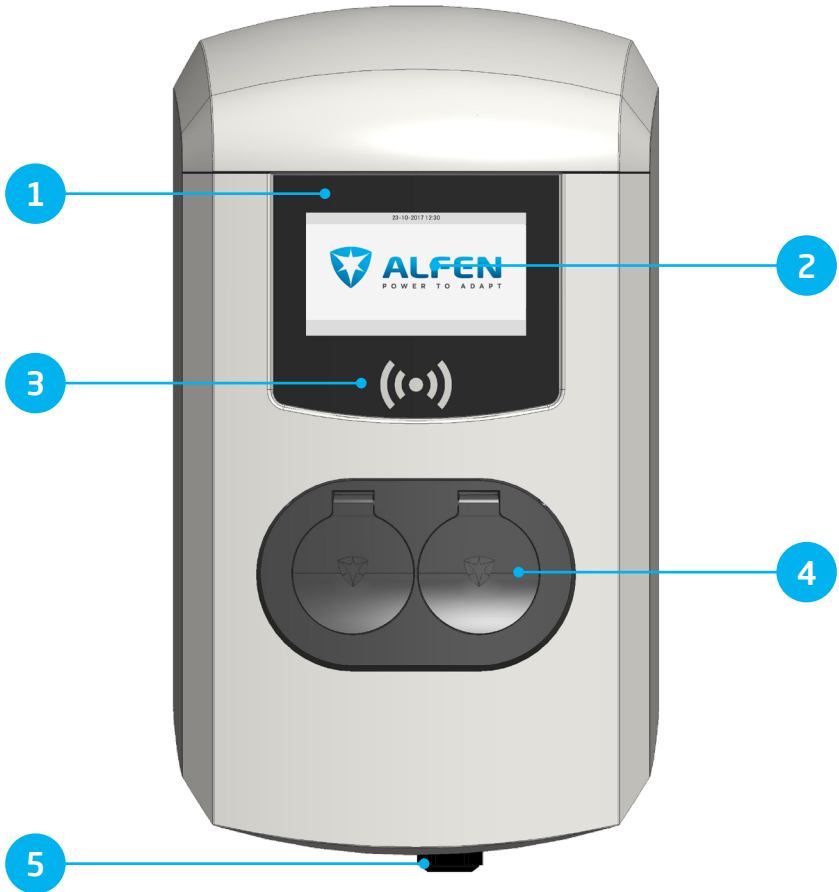

INSIDE / INTÉRIEUR



Step-by-step Eve Double Pro-line FR installation and commissioning

Congratulations on your purchase of an Alfen charging station for electric vehicles!

To ensure safe installation, and full utilisation, of all advanced features of your charging station, we recommend that you read this manual carefully and save it for future reference.

While we have done our utmost to provide you with a complete and comprehensive manual, it may occasionally be subject to updates and content improvement. The latest version will always be available for download at www.alfen.com.

TABLE OF CONTENTS

1	Safety and usage instructions	7
1.1	Purpose and intended audience	7
1.2	General safety	7
1.3	Disclaimer	7
1.4	Copyright	7
2	Product	8
2.1	The charging station	8
2.2	User interface	9
2.2.1	Status indications on the display	9
2.2.2	Status indicator symbols	9
2.3	Operation	10
2.4	Optional E-socket	11
2.5	Access control for local authorisation	12
2.5.1	Installing the master key	12
2.5.2	Adding and removing passes in the local database	12
2.5.3	Removing the Master Key	12
2.6	Technical specifications	13
2.6.1	Eve Double Pro-line FR model overview	13
2.6.2	Eve Double Pro-line FR specifications	13
2.6.3	General product specifications	13
2.6.4	Communication and protocols	14
2.6.5	Communications security	14
2.6.6	Available memory	14
2.6.7	User circumstances	15
2.6.8	Casing	15
2.6.9	Input / power supply	16
2.6.10	External protection according to EV/ZE-Ready	16
2.7	Optional factory settings	17
2.8	Accessories	17
3	Installing and connecting	18
3.1	Installing and connecting	18
3.2	Mounting and installation requirements	19
3.3	Mechanical installation	19
3.4	Electrical installation	20
4	Commissioning the charging station	22
4.1	Safety instructions prior to usage	22
4.2	Commissioning Eve Single Pro-line FR	22
4.3	Configuring the charging station with Service Installer (application)	22
4.3.2	Using the Service installer application	23
4.3.3	Changing language settings	23
4.4	Activate functionality with the Service Installer application	23
5	Connectivity	24
5.1	Management systems	24
5.2	Setting up a connection	24
5.2.1	Wireless connection	24
5.2.2	UTP (Ethernet) connection	24

5.3	Registering your ICU EZ account	25
5.4	Managing settings	25
5.5	Register your charging station to your own management system	25

Appendices

Appendix A: Error codes and problem solving	26
Appendix B: Default configuration of optional factory settings	28
Waste Electrical and electronic equipment (WEEE)	33

DECLARATION OF CONFORMITY

Manufacturer information:

Alfen ICU B.V.
Hefbrugweg 28
1332 AP Almere
The Netherlands

Declares the conformity of the product:

Charging stations of the type Alfen Eve

Pursuant to European directives:

Low Voltage Directive 2014/35/EU
EMC Directive 2014/30/EU

Applied (harmonised standards)

- NEN-EN-IEC 61851-1
- NEN-EN-IEC 61851-2
- NF-EN-IEC 61851-1
- NF-EN-IEC 61851-2
- DIN EN 61851-1
- DIN EN 61851-2
- BS EN 61851-1
- BS EN 61851-2
- CEI EN 61851-1
- CEI EN 61851-2

All mentioned products are labelled with the CE mark.

Almere, The Netherlands, 3 juli 2017

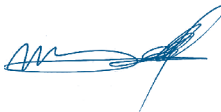

M. Roeleveld, Msc.

1. SAFETY AND USAGE INSTRUCTIONS

1.1 Purpose and intended audience

The Alfen Charge Point (the "Product") is intended exclusively for charging electric vehicles and, when installed correctly, may be used by untrained individuals.

Installation, commissioning and maintenance of this Product may only be performed by a qualified electrician (Alfen-ICU certified partner). It is essential that the qualified technician has:

- Expertise on all relevant general and specific rules regarding safety and incident prevention
- Comprehensive knowledge of applicable electrical regulations.
- The ability to identify risks and avoid potential hazards.
- Received and read these installation and operation instructions

1.2 General safety



DANGER!

These safety instructions are important to ensure safe operation. Failure to comply with them in accordance with general electrical safety regulations could result in a risk of electrical shock, fire and/or life threatening injury.

Using this product is expressly prohibited in the following situations:

- In the vicinity of explosive or highly flammable substances.
- If the product is located in or close to water.
- If the product or its individual components are damaged.
- Usage by children or individuals not able to properly assess the risks associated with using this product.

Alfen ICU B.V. ("Alfen") shall not be liable in any way, for any kind of damage, and all warranties on both the product and accessories shall become void where:

- The ambient temperature is below -25°C or above 40°C.
- the Products have been subject to misuse, faulty installation or maintenance; or
- the Products have been disassembled, modified or repaired; or
- the manuals, operation and maintenance instructions which are applicable for (parts) of the Products or have been provided by Alfen are not complied with; or
- the Products are used in the vicinity of explosive or highly flammable substances or in or near to water; or
- in case of normal wear and tear; or
- there is a failure of the distribution network; or
- there is a force majeure situation, or the defect is otherwise caused from the outside.

More extensive safety information is available in the relevant sections of this document.

1.3 Disclaimer

This manual applies to the Product equipped with firmware version 4.4.0 or higher.

This document has been subjected to rigorous technical review before being published. It is revised at regular intervals, and any modifications and amendments are included in the subsequent issues. The content of this document has been compiled for information purposes only.

Although Alfen has made its best efforts to keep the document as precise and up-to-date as possible, Alfen shall not assume any liability for defects and damage which results from the use of the information contained herein.

In no event will Alfen B.V. be liable for direct, indirect, special or consequential damages (incl. loss of profits) resulting from any errors or omissions in this manual. All obligations of Alfen are stated in the relevant contractual agreements. Alfen reserves the right to revise this document from time to time.

Any deviation to the Products including, but not limited to, customer-specific modifications (like customisation by placing stickers, SIM cards or the usage of different colours), hereafter referred to as 'Customisation', can alter the final product experience, product appearance, product quality and/or product lifespan. Alfen is not liable for any damage to, or caused by, the product (including applied Customisation) if this damage is caused by this applied Customisation. Contact your dealer for more information on Customisation versus the default product.

1.4 Copyright

Copyright © Alfen N.V. 2022. All rights reserved. The disclosure, duplication, distribution and editing of this document, or utilization and communication of the content are not permitted, unless authorized in writing. All rights, including rights created by patent grant or registration of a utility model or a design, are reserved.

2. PRODUCT

2.1 The charging station

On pages 2 and 3 of this manual, you will find the images of the Eve Double Pro-line FR product line. In this chapter, you will find more information on the contents of the charging station and how it can be used to charge your vehicle.

The charging station

Outside

- ① Charging station identification number
- ② Colour display
- ③ RFID card reader and authorisation indicator
- ④ Type 2 plug connection
- ⑤ Cable gland(s) for power cable(s), entry
- ⑥ Grommets for E-socket cable(s)
- ⑦ Port for Service Installer/UTP cable
- ⑧ Identification label

Inside

- ⑨ Threaded holes for wall mounting
- ⑩ SIM card holder (ref. image 9 for detailed location)
- ⑪ RJ11 connector port for Active Load Balancing

Bottom

- ⑫ UTP (Ethernet) connection
- ⑬ Connector for display
- ⑭ On/off switch (4 pole) (model 904461206)

Identification label

The identification label ⑧ found on the bottom of the charging station specifies elements such as:

- Model, production date and serial number.
- Technical specification number.
- Article number and maximum charging current.

When contacting Alfen, always have your serial number available to facilitate quick support.

2.2 User interface

The Eve Double Pro-line FR has a colour display which informs the user on the progress of the charging by using status indications.

2.2.1 Status indications on the display

General information on charging station

- ① The charge point ID: Identification is determined by the reseller or maintainer of the central management system. You can, for example, use this ID to convey to a helpdesk for which charging point you need support.
- ② Date and time: these are set through a maintenance system (automatically) or during installation, using the Service Installer application. If the product does not have a current time, this field is invisible.

Status and information screen

The charging station informs the user of its current status and provides the user with a response to the actions performed. The following information is available:

- ③ Status information.
- ④ Maximum charging capacity of the outlet.
- ⑤ Status indicator (symbols, see figure 2)
- ⑥ Current charging capacity to the connected vehicle.
- ⑦ Energy picked up during the current transaction.
- ⑧ Duration of the current transaction.

Instruction field

- ⑨ Progress bar displays the progress of the charging process in which user is involved. A full progress bar indicates the necessary steps are completed and charging will start.
- ⑩ Usage instructions will be displayed in this location. Where an error occurs, an error code and instruction will be shown (see Appendix A for more information). Displayed when the auxiliary E-socket is in use.
- ⑪

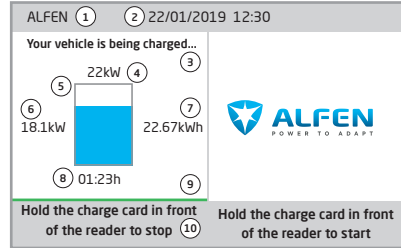

Figure 1: Display of Eve Double Pro-line FR during charging

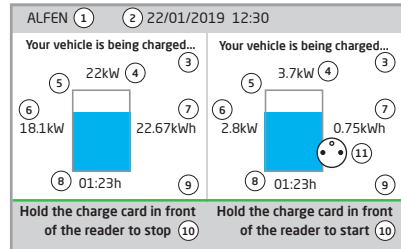

Figure 2: Display of Eve Double Pro-line FR during charging with Type 2 socket and E-socket simultaneously

2.2.2 Status indicator symbols



Charge card accepted, cable connected



Communicating with vehicle or charging complete



E-socket in use

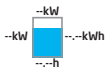

Charging transaction active, with charging speed indication



Error, notification with error code



Warning, notification with error code

2. PRODUCT

2.3 Operation

Specific user actions are presented in a sequence that clearly shows the progress and corresponding status indications. The first steps can be conducted in any sequence. Upon detecting a charging cable or charge card, all Eve Double Pro-line FR products will show a green status. The light blue (cyan) colour will only be displayed if and when a connection between the vehicle and charging station is established.

Start

Operation Plug & Charge - Authorisation without a charge pass



Pro-line



Stop



Pro-line



Start

RFID - Charging station with user authorisation (only for Pro-line)



Pro-line



Stop



Pro-line



2.4 Optional E-socket

The E-socket is an optional accessory on the Eve Double Pro-line FR charging points for vehicles that need to be charged via a domestic plug. Pay attention! Countries may have restrictions on the load capacity of the E-socket. Check and follow national and local legislation for country-specific regulations and recommendations.



Figure 3 : Eve double Pro-line FR with E-sockets

REMARK

- The type 2 socket and type E-socket connector outlets on one side (left or right) cannot be used simultaneously.
- Switching between outlets is not possible for a single transaction.
- Smart charging: When both sockets are in use simultaneously type 2 sockets for EV charging will always get priority over type E-sockets because E-sockets can not be controlled dynamically.

2. PRODUCT

2.5 Access control for local authorisation (RFID)

To control local user access to an Alfen Eve Double Pro-line FR charging station, you need to install an RFID card as the 'Master key'. With this Master Key, you can determine who can use your charging station.

REMARK

Your charging station must be configured correctly in order to accept Master Keys. For stand-alone charge points this functionality is automatically ON. If the charging station is delivered with a pre-programmed management system, this functionality will be OFF.

2.5.1. Installing the Master Key

A Master Key can be easily installed using the following steps:

- ① Select an RFID card, like the included Alfen pass, that complies with the specifications mentioned in paragraph 2.6.2.
- ② Hold the RFID card in front of the card reader for 10 seconds. Initially the charging station does not recognise the pass and will give a warning first. You can ignore this.
- ③ After 10 seconds, the RFID card will be registered as the Master key. The following icon appears on the screen:



! NOTICE!

The Master Key cannot be used for charging. It is only used for access control of the charging station.

The charging station will only recognise one RFID card as the Master Key.

2.5.2 Adding and removing passes in the local database

Once the Master Key is registered, it can be used to add or remove charging passes from the local database. For every pass held in front of the charging station, the station will give a sound signal. Follow the on-screen instructions to manage access control:

Hold the Master Key in front of the card reader

Hold the charge pass that you want to add in front of the card reader

Hold the charge pass that you want to remove in front of the card reader

Display



Supporting text on display

Master Key held in front of reader

Card added

Card removed

Add or remove charge passes

If you add or remove a charge pass by mistake, you can immediately hold it in front of the card reader to undo the action.

To close the database, hold the Master Key in front of the card reader once more.

REMARK

To prevent the local database from being 'open' to access control, the menu will close automatically if no card has been added or removed after 10 seconds. The symbol will disappear from the display.

2.5.3 Removing the Master Key

A Master Key can only be removed using the Service Installer application. If necessary, you can ask for help from one of our technicians. This might, however, incur costs. Therefore, always keep the Master Key in a safe location. More information on the use of the Service Installer application can be found in paragraph 4.3.2.

2.6 Technical specifications

2.6.1 Eve Double Pro-line FR model overview

Models

Model name	Article no.	OCPD chargePointModel
1-phase, Display, 2x socket Type 2S (shutters), max. 1x32A input current	904461215	NG920-61215
1-phase, Display, 2x socket Type 2S (shutters), max. 2x32A input current	904461216	NG920-61216
3-phase, Display, 2x socket Type 2S (shutters), max. 1x32A input current	904461205	NG920-61205
3-phase, Display, 2x socket Type 2S (shutters), max. 2x32A input current	904461206	NG920-61206

2.6.2 Eve Double Pro-line FR specifications

Operation	Plug & Charge authorisation RFID authorisation Central system Third-party apps
Display	7" TFT colour display, 800 x 480 pixels
Status indication	integrated on display
RFID card reader	RFID (NFC) ISO/IEC 14443A/B, MiFare Classic 13.56 MHz, DESFire Maximum length: 7 bytes
Mobile network possibilities	GPRS
Energy meter	MID certified
Status indication	Integrated in the display
Access	Locations with restricted access Locations with non-restricted access

2.6.3 General product specifications

Number of outlets	<ul style="list-style-type: none"> • 2 • Optional two E-socket outlets available
Types of outlets	<ul style="list-style-type: none"> • Socket Type 2 shutters, conform IEC62196-2 ed. 2 • Support for accessory (803873065-ICU) : E-socket, conform IEC 60884-1, CEE7/5, NF C 61-314
Supported power systems	TN-C, TN-C-S, TT, IT* * Caution: not all vehicles support the IT system. In that case, or with 3-phase charging, an isolation transformer is required.
Nominal output voltage (+/- 10%)	<ul style="list-style-type: none"> • 230VAC, 1-phase products • 400VAC (3x230VAC), 3-phase products • Optional E-socket, 230VAC, 1-phase
Maximum design current	<ul style="list-style-type: none"> • 32A per phase • Optional E-socket, Max. 16A
Maximum design power	7.4kW, 1-phase products 22kW, 3-phase products 3.7 kW, 1-phase for optional E-socket
Connection clamps	Cable gland, clamping range for 17-25.5mm cable thickness. Cable clamps range: <ul style="list-style-type: none"> • Max 16mm² per wire
Cable clamps for optional E-socket	2.5mm ² per wire (multi-core VDS), 7-core

2. PRODUCT

Main switch	4-pole pin, 80A, 400 VAC (904461205, 904461215, 904461216) 8-pole pin, 40A 400 VAC (904461206)
Activation relay	Integrated, simultaneous activation Extra safety relay in series
Overcurrent protection	Integrated in firmware; shutdown at: 105% after 1,000 seconds; 110% after 100 seconds; 120% after 10 seconds; 150% after 2 seconds.
Residual current protection	Type B 30 mA, per outlet
Available in- and outputs	RJ45 (Ethernet/LAN) RJ11 (active load balancing)
Load balancing	Optional Mandatory for charging current greater than 16A per phase (904461215, 904461205)

2.6.4 Communication and protocols

Controller	Central unit for charging currents and communication
Vehicle communication	Mode 3 in accordance with IEC 61851-1 ed. 3 (2017)
Internet/networking possibilities	Mobile network communication, Ethernet/LAN
Communication protocol Central System	OCPP 1.5 (JSON), OCPP 1.6 (JSON)
Supported RJ45 protocols	OCPP TCP/IP
Supported RJ11 protocols	DSMR 4.0-4.2 and SMR5.0 (P1 port) I/O for supporting external relay
Modbus (Master)	TCP/IP

2.6.5 Communications security

SIM card	Mini SIM card APN username and password
Central System authentication	TLS 1.2 x509 2048/4096 bit root certificate
EVSE authentication	HTTP Basic authentication, with or without TLS
Remote console access (SSH, telnet)	Not supported
Diagnostic files	Encryption: AES 128 bit
Firmware update files	Encrypted and digitally signed Encryption: SHA256 hash (pkcs1/PSS padding with 2048 RSA key) Signature: RSA public key 2048 bit
EVSE Internal Flash	AES 128 bit (erased when read)
Root certificate	Installed in the factory, update through UpdateFirmware file

For more information on the implementation of information security in Alfen Charging Equipment, you can contact cpadmin@alfen.com

2.6.6 Available memory

Charge passes	Local list: approx. 800 charge passes (via the Backend) White list: approx. 1,200 charge passes (local)
Transaction database	Approx. 1,500 transactions (of 4h with 15min Wh-metering values)
Logging for diagnostics	Approx. 45,000 lines

2.6.7 Use conditions

Operating temperature	-25°C - 40°C
Relative atmospheric humidity	5 - 95 %
Electrical safety class	I
Degree of protection (casing)	IP54
IK protection (mechanical impact)	IK10
Stand-by use	Ca. 9-12 W
Environmental conditions	Indoor use Outdoor use

**NOTICE!**

The operating temperature assumes the ambient temperature of a product delivered in the default casing colour 'RAL9016'. Direct exposure to sunlight may have an adverse effect on the temperature range.

The ambient temperatures in the table above refer to a product in its default casing, colour RAL9016. Other (darker) colours may have an adverse effect on the product. If the product is exposed to lower or higher temperatures, continuous operation cannot be guaranteed. If temperatures exceed the maximum values, the charging station will automatically decrease the charging current to decrease the internal temperature.

This stabilises the internal temperature and makes it less likely that a transaction will be unexpectedly paused.

If the product is directly exposed to sunlight, the automated temperature management may automatically start below the maximum ambient temperature.

2.6.8 Casing

Type	Wall-mounted unit
Mounting options	Wall mounting or mounting post (accessory)
Material (cover)	Fibre-reinforced polyester (Sheet Moulding Compound - SMC)
Colour (cover)	RAL 9016 (Traffic white)
Material (rear)	Fibre-reinforced polyester (Sheet Moulding Compound - SMC)
Colour (rear)	RAL 7043 (Traffic grey B)
Locking	Anti-theft screws
Dimensions (H x W x D)	
Casing	590 x 338 x 230 mm
Product packaging	740 x 350 x 250 mm
Weight	
Casing	Approx. 20 kg
Complete, incl. packaging	Approx. 21,5 kg
Complete, incl. packaging and pallet	Approx. 25 kg

**NOTICE!**

Where products are exposed to the elements, the case can be subject to gradual aging of the material, which can result in product discolouration over time. Therefore, wherever possible, place the product in a sheltered place to optimise the life of the materials.

2. PRODUCT

2.6.9 input / power supply



NOTICE!

Your installation must comply with the standards and regulations of the location (country) where it is located. The tables below are advisory and based on proper practical functioning of the charging stations; provided that all prerequisites are satisfied.

Printing errors expressly reserved

Input: minimum advised cable diameters (based on assumed max. 50m cable length)	1-phase	904461215	16A: 3 x 4 mm ²	32A: 3 x 6 mm ²
	1-phase	904461216	16A: 3 x 4 mm ² per wire	32A: 3 x 6 mm ² per wire
	3-phase	904461205	16A: 5 x 4 mm ²	32A: 5 x 6 mm ²
	3-phase	904461206	16A: 5 x 4 mm ² per wire	32A: 5 x 6 mm ² per wire

Short circuit protection	Single power supply, 1-phase:	With breaker circuits: 1 x 40 A max 1P, kar. B or C	With fuses: 1 x 35A max, gG
	Double power supply, 1-phase:	2 x 40 A max, 1P, kar. B or C	2 x 35A max, gG
	Single power supply, 3-phase:	1 x 40 A max, 3P kar. B or C	3 x 35A max, gG
	Double power supply, 3-phase:	2 x 40 A max, 3P kar. B or C	6 x 35A max, gG

If you have opted for a capacity less than or equal to 16A (3.7 kW or 11 kW charging), 20A instead of 40A is sufficient.

Residual current protection (possibly in combination with breaker circuits)	Residual current breaker (optional): min 100mA (S) Selective, 4P, tupe A EV, of B,
	Single power supply: 1x40 A
	Double power supply: 2x40 A

Nominal voltage	• V_{U1-N} : 230V (+/-10%)
	• V_{U2-N} : 230V (+/-10%)
	• V_{U3-N} : 230V (+/-10%)
	• V_{U1-U2} : 400V (+/-10%)
	• V_{U1-U3} : 400V (+/-10%)
	• V_{U2-U3} : 400V (+/-10%)
	• V_{PE-N} : \approx 0V

Nominal frequency	50 Hz / 60Hz
-------------------	--------------

Grounding	TN system: PE wire)
	TT system: Independently installed ground electrode <100 Ohm spreading resistance
	IT system: connected to a shared reference (common earth) with other metal parts

Connection method	Permanently connected
-------------------	-----------------------

2.6.10 External protection according to EV/ZE-Ready

IEC 61000-4-16 or IEC 61543

Frequency range	Level 3		Level 4	
	Cont. test Vrms (V)	Current (mA)	Cont. test Vrms (V)	Current (mA)
1 kHz - 1.5 kHz	1	6.6	3	20
1,5 kHz - 15 kHz	1 - 10	6.6 - 66	3 - 30	2 - 200
15 kHz - 150 kHz	10	66	30	200

2.7 Optional factory settings

Description	Options
Authorisation	Plug & Charge RFID*
Maximum charging current	16A 32A*
Smart Charge options (see Appendix B)	Off Standard load balancing* Active load balancing (P1)* Smart Charging Network*
Own logo in display (only Pro-line)	Off (Alfen logo) On (your own logo)*
Languages supported	English, Dutch, German, French, Spanish, Portuguese, Italian, Norwegian, Swedish, Finnish
User availability if temporarily offline	Accept all RFID passes Only valid passes in database Not available
Action if plug is released on vehicle side	Stop transactions and release the plug Pause charging until cable plugged back in
Choice of management system	Stand alone ICU Connect* other options*
Communication through *	GPRS UTP/LAN Auto detect

* Settings may incur additional costs.
The default settings are always displayed first.

2.8 Accessoires

Mounting post FR	Art. 934459002
Dimensions (H x W x D)	1,430 x 180 x 80 mm
Material	Aluminium with powder coating
Colour	RAL 7043 (Traffic grey B)
Packaging (H x W x D)	1,460 x 360 x 280 mm
Weight	11 kg
Cable cover E-socket	Art. 803873064-ICU* *Mounting post spare part
Concrete base	Art. 833829300-ICU
Dimensions (H x B x D)	570 x 350 x 220 mm
Weight	42 kg
Metal base	Art. 803828601-ICU
Dimensions (H x B x D)	598 x 204 x 300
Weight	7.8 kg
Packaging (H x W x D)	50 x 295 x 620
Additional RFID card	Art. 203120010-ICU
E-socket	Art. 803873061-ICU
Wall-mounting bracket	Art. 803873062-ICU*
E-socket	*E-socket spare part

3. INSTALLING AND CONNECTING

Package content

Content of the package of the charging station consists of: Alfen Eve Double Pro-line FR installation manual, wall mounting block and assembly accessories, RFID charging pass (depending on the selected options).

1 x



Eve Double Pro-line FR

1 x

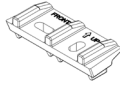

Wall-mounting frame

1 x



Allen key

2 x



Anti theft screw M8x20

1 x



This manual

1 x



Quick Installation Guide

1 x



Hex bolt M8x50

4 x



Washer

4 x



Nylon plug S10x50

1 x



Additional swivel for Eve double Pro-line FR with double feeder cable

3.1 Installing and connecting

Carefully read these instructions prior to installing the charging station. Alfen ICU B.V. is not liable for any consequential damage caused by usage of this manual.

REMARK

The installation must be carried out by a qualified professional who has read this manual and works in compliance with IEC 60364 standards. Neglecting this may lead to severe injuries or hazardous situations while working with electricity.

REMARK

This work may not be carried out during rain or if air humidity exceeds 95%.

REMARK

A charging station must always be installed on a dedicated power circuit.

! DANGER!

Hazard of fatal injury if installed incorrectly!
Non-compliance with the installation and environment requirements may lead to hazardous situations while working with electricity.

REMARK

Protect Alfen products installed in public areas and car park sites from mechanical impact and/or collisions which can cause damage to the equipment.

! DANGER!

The charging station contains electric components that may still contain electrical charge after being disconnected. Wait at least 10 seconds after disconnection before commencing work.

! WARNING

The adaptors or conversion adaptors are not allowed to be used.

! WARNING

Cord extension sets are not allowed to be used.

! DANGER!

The electric system must be entirely disconnected from every power source prior to performing installation or maintenance work!

REMARK

The conditions at the specific location may influence the installation requirements.

3. INSTALLING AND CONNECTING

3.2 Mounting and installation requirements

Refer to the table in paragraph 2.6.9 and 2.6.10 to review the safety features and the required cable thicknesses to ensure a proper connection.

Ensure that the following requirements for installing the Alfen Eve have been met:

- The cable trajectory from the main distribution station up to the Alfen Eve must be protected against short-circuits and overcurrent using:
 - B or C residual current fuses (or otherwise in compliance with local standards and regulations).
 - Type gG fuses (or otherwise in compliance with local standards and regulations).
- The cable trajectory and the charging station are part of a TN-S system; the station must be grounded via the main distributor.
- The cable trajectory must be installed in compliance with the usual locally applicable professional standards.

REMARK

The system and cables must be installed based on the maximum charging rate at the entry or entries of the charging station. This must be based on a continuous load (all simultaneous loads). The cable diameters mentioned in this manual are indicative. The technician remains responsible for determining the correct cable diameter and compliance with applicable standards and regulations.

While selecting a location to install the Alfen Eve, the following criteria must be taken into account:

- Never install in a potentially explosive atmosphere.
- Never install in areas prone to flooding without implementing compensating measures.
- Always fully comply with local technical requirements and safety regulations.
- The installation site must have a levelled and solid underground.
- Maximum atmospheric humidity of 95%.
- Ambient temperature of -25 °C to 40 °C.
- Temperature difference within 24 hours max. 35 °C.
- The recommended installation height is 70 to 120cm from the ground to the bottom side of the enclosure.
- Ensure that the charging station is located in such a way it's sockets can be reached easily with a charging cable. The charging cable must not be under tension while connected to the vehicle.
- Prevent road users from being able to drive over the cable.
- Prevent pedestrians from being able to trip over cables.
- Ensure that the UTP/Ethernet connection on the bottom side of the charging station is covered to prevent it from being unintentionally disconnected or used by unauthorised individuals.

3.3 Mechanical installation

Use the following tools and equipment to install the Eve:

- Spirit level
- Impact drill
- Phillips screwdriver
- Screwdriver for a terminal block
- Pencil and the enclosed drill template
- Torx screwdriver (T25)
- Wire stripper
- Allen wrench
- 4 x M8 x 50mm hex bolts
- 4 x ≤ 10 x 50mm nylon plugs
- 4 x washers

Wall mounting: Apply the drill template.

REMARK

Verify the indicated measures with a tape measure.

The distances between the drill holes are 123.8 mm (top side), 39.6 mm (bottom site) and 434.3 mm (vertical).

1. Cut the drill template from the carton packaging.
2. Place the drill template at the desired location.
3. Use a spirit level to verify that the template is applied levelled.
4. Use the drill template to mark the drill holes.
5. Drill the holes at the marked points.
6. Verify the drill holes.

Installing the mounting block

1. Push fitting wall plugs into the four drill holes.
2. Attach the mounting block on the wall by using two M8 hex bolts in the two bottom drill holes.

Mounting post: Install the post with the concrete pedestal or metal pedestal (accessory):

1. Dig a hole of approx. 50x50cm with a depth of 65cm.
2. Place the concrete or metal pedestal in this hole.
3. Attach the post on the pedestal with four threaded bolts M10x25 mm and the corresponding rings (ref. image on the cover or the pedestal's installation manual).
4. Attach the mounting block with two screw bolts M10x25 mm.
5. Attach the charging station on the post with two screw threads M10x25 mm.
6. Attach the ground wire on the post with M4x12 mm screws and an M4 washer.
7. Guide the ground wire through the concrete pedestal and the base to the charging station.
8. Attach the cover plate to the post with the anti-theft bolt M8 x 15 mm (ref. image 2).
9. Refill the hole in which the pedestal is placed and level the surface.
10. Once completed, cover the area with a levelled protection such as tiles.

3. INSTALLING AND CONNECTING

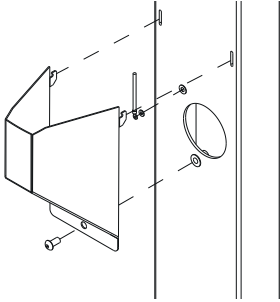

Figure 4: Fixing the cable cover

Preparing the charging station

Do not remove the transparent foil from the casing during installation. This helps to prevent damage such as scratches on the display. Before installation, the white cover must be removed from the charging station. This is done as follows:

The front cover is firmly attached to the charging station and is secured with two screws at the top and bottom.

1. Place the device on its back, preferably on a soft under ground such as the packaging of the Eve.
2. Remove the screws on the bottom with an Allen key.
3. Use a Torx M5 (T25) screwdriver to loosen the two screws on the side of the backside of the casing (ref. image 5).
4. Save these screws somewhere safe, they are required later.
5. Carefully lift the white cover, starting at the bottom in an upwards direction.
6. Take the entire white part of the unit and put it at a safe location where it cannot be scratched or damaged otherwise; for instance in the packaging of the Eve. Be particularly careful with the display screen.

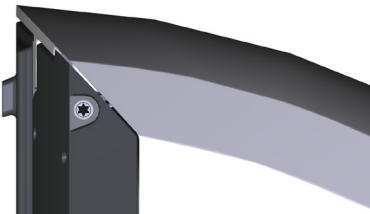

Figure 5: Location of Torx T25 bolts to release, adjust and fasten the enclosure

Installing the charging station

1. Place the station onto the already installed mounting block, in a vertical downward movement.
2. Secure the station on the top side with two hex bolts (max. diameter 8mm) at the indicated position (ref. image 4).

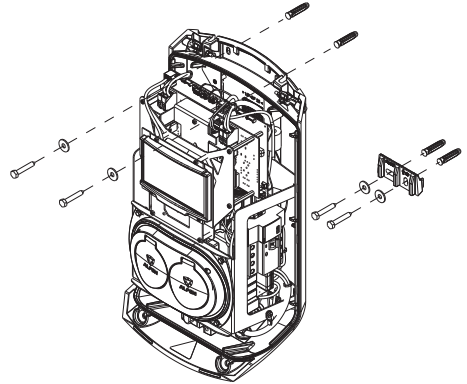

Figure 6: Wall mounting

3.4 Electrical Installation

! WARNING

Carefully read and follow all safety instructions in this manual!

! DANGER!

The electric system must be completely disconnected from every power supply prior to carrying out installation and maintenance work!

1. Pull the power cable through the cable inlet, (© on page 2).
2. Pull the power cable at least 15 cm into the housing from the ground or wall.
3. Secure the power cable in the cable inlet by tightening it so that the power cable cannot be removed. The cable gland also functions as a strain relief.
4. The subframe with the type 2 charging sockets must be detached, refer to images 5 and 6. The subframe is equipped with a clicking mechanism on all four connection points. Detaching the subframe is best done by first detaching one side (left or right) followed by the other side.

3. INSTALLING AND CONNECTING

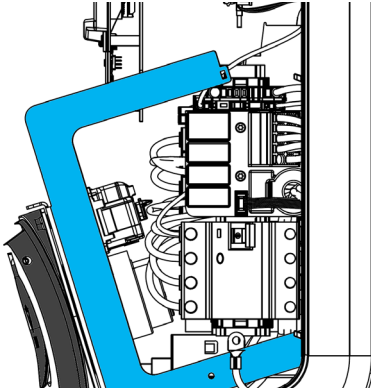

Figure 7: Detachable subframe

! NOTICE!

Make sure the cables do not become trapped while putting the subframe back into place!

8. Verify that the residual current devices inside the charging station are enabled.
9. Put the main switch on the I (ON) position. If needed, use a special wrench to simplify switching.
10. Push the white part of the housing with the two screw caps into the openings at the top of the back cover.
11. Use a Torx T25 screwdriver to tighten the two screws on the top side of the unit (image 3).
12. Properly close the white part of the cover by pressing on it and screwing the M8 x16 anti-theft screws in the backside.

! NOTICE!

Absolutely no gaps may be present between individual parts of the casing. This is detrimental to moisture and dust protection, which has an adverse effect on the life-cycle of the charging station.

13. Now remove the transparent foil from the casing.

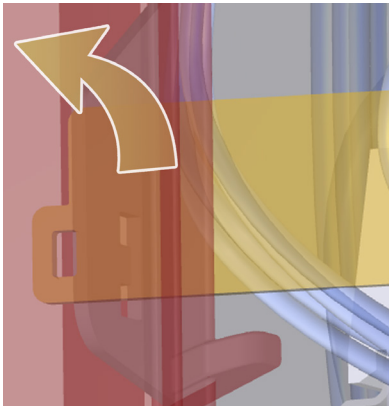

Figure 8: Subframe clicking mechanism

5. Remove the sheathing from the cables with a wire stripper to connect the exposed wires in the main switch (13 on page 3).

! WARNING!

Always first connect a proper ground conductor!

6. Connect the wires to the main switch.
7. Place the subframe back in position by connecting the connection points with the back frame.

4. COMMISSIONING THE CHARGING STATION

REMARK

The Service Installer application is available for download for Microsoft Windows on: www.alfen.com/en/downloads. See the chapter 'applications'. If you do not yet have an account to use the Service Installer application, you can request one through <http://support.alfen.com> > 'Configuration Tool' > 'Sign up for an account'.

4.1 Safety instructions before use

Follow the safety instructions below before commissioning your charging station:

1. Make sure the charging station is properly connected to the power supply as described in this manual.
2. Make sure the power supply is separately protected by an appropriate breaker.
(circuit breakers or fuses)
3. Make sure the charging station is installed in accordance with this manual.
4. Make sure the cover is always closed during normal operation.
5. Make sure the charging cable is not twisted and that the cable, plug and casing do not have any damage.

4.2 Commissioning Eve Single Pro-line FR models

Turn on the local power supply. The charging station will run self diagnostics. The following steps will occur within a few seconds:

1. The output is tested:
 - Testing locks
 - Testing internal relays: you will hear them click.
2. The display will illuminate briefly.
3. The display turns on and displays the message 'Charging point is powering up'.
4. The display will show the start screen, recognisable by the logo on the screen.
5. The Eve Single Pro-line FR is now ready for use. If the charging station is set to connect with the management system, it will do so directly and automatically.
6. If desired, the charging station can be configured further. Use the Service Installer software package to gain access.
7. Have you had the charging station configured for Smart Charge functionality? If so, check the settings with the Service Installer application to optimally configure the charging station for the local situation. More information is available in Appendix B.

4.3 Configuring the charging station with Service Installer (application)

4.3.1 Preparation

Eve Single Pro-line FR charging stations are easily configured using the Service Installer application. This application allows you to access many settings, view the factory settings and see all the completed transactions and recognised charge passes.

The version number of the Service Installer application is connected with that of the firmware to show you which new functionalities are supported by your charging station.

Tip: Before installing the charging station, make sure you have a user account and are using the newest version of the Service Installer application. You can request an account at: <http://support.alfen.com>. Click on 'Sign up for an account'. Note that new account creation may take several working days.

Connect the charging station to your laptop with an Ethernet cable (UTP).

4. COMMISSIONING THE CHARGING STATION

4.3.2 Using the Service Installer application

When you log in, you will see the charging station settings divided into different categories. In most cases, the charging station has already been configured according to preferences with few adjustments necessary. If you ordered the smart charge options (see Appendix B), check the settings and adjust them where necessary to optimally configure the charging station for its location.

The Service Installer application is divided into the following categories:



General charging stations settings and status information



Settings on the user interface/display



Power settings to configure the charging station for the local grid



Load balancing, all of the smart charging options and settings in one location



Authorisations: managing charge passes and methods for user authorisation



Activity log of the charging station



Transaction information for historic and current transactions



Live monitoring: Take a look at the status of the charging station



Connectivity settings e.g management system connection settings (see paragraph 4.3), mobile communication (GPRS) and local network settings.



Warnings: shown in a single overview for quick analysis

Functionalities shown in grey were not specified when ordering and so the charging station does not support them.

4.3.3 Changing language settings

Alfen's charging station interface supports ten different languages.

Changing the language can be done in two ways:

1. Via the Service Installer application; proceed from General Settings to 'Localisation'. Where, you can edit the language settings.
2. Via a connected management system; Go to the language settings screen on the management platform. Every Alfen charging station has the 'Language' setting item. The table below provides an overview of the languages supported.

Language	Country code	Language	Country code	Language	Country code	Language	Country code	Language	Country code
Dutch	nL_NL	German	de_DE	Spanish	es_ES	Italian	it_IT	Swedish	sv_SE
English	en_GB	French	fr_FR	Portuguese	pt_PT	Norwegian	nn_NO	Finnish	fi_FI

4.4 Activate functionality with the Service Installer application

The charging station is connected to Alfen through the Service Installer Application. When necessary, you can retrieve the last known settings making it possible to go back to factory settings or to retrieve new settings.

Alfen charging stations offer the unique possibility to be upgraded with new functionalities, even if these did not yet exist when the station was purchased. Returning to factory settings or retrieving a new 'license' will be sufficient. If the option is then activated, you can use and install it as desired.

5. CONNECTIVITY

5.1 Management systems

Alfen charging stations are intelligent, and can communicate with a range of online third party management systems or our own, Alfen ICU EZ. All of these provide the opportunity to track users' energy consumption, control charging remotely and simplify charge point maintenance via remote access.

Each charging station is already configured during production to directly connect with the chosen management system, with internet connection established via GPRS or a UTP (Ethernet) cable connection depending on the model and/or customer preference. Where a GPRS connection is available, and was specified, the charge point is usually supplied with the SIM card installed and will connect automatically once the product is powered on. If the SIM card holder (item. ⑩ on page 3) does not contain a SIM card, it will either be included in the package or can be back-ordered. If in doubt, please contact the reseller or provider.

or more information on the Alfen management system ICU EZ, visit: www.alfen.com/en/ev-charge-points/services

5.2 Setting up a connection

5.2.1 Wireless connection

To connect wirelessly, the charging station must be equipped with a SIM card suitable for GPRS. The correct settings must also be chosen to connect with the desired management system.

There are several (shortcuts) in the Service Installer to support this. These allow for quick selection of the desired management system and related settings. Always check the signal strength after installation, using the Service Installer.

REMARK

Whether and which management system a charging station connects to is arranged by the company reselling the product. This includes the services offered via this system, which are outside the scope of delivery of Alfen.

Where Alfen ICU EZ online management system was requested, the Eve Single Pro-line FR will already have a SIM card installed and will connect automatically when the product is powered on. If you chose another management system when ordering, you might need to install the SIM card yourself. Image 9 shows the location of the SIM cardholder.

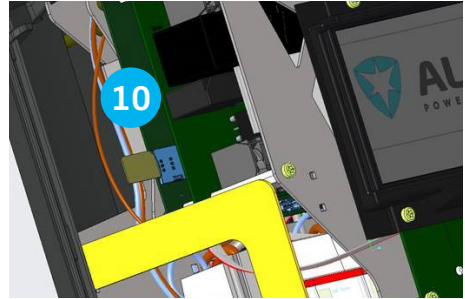

Figure 9: Location of the SIM card holder.

5.2.2 UTP (Ethernet) connection

Which cable do you need?

A CAT5 UTP cable (max. 100 metres) is the minimum required to connect the charging station to the internet. This cable is suitable for speeds up to 100Mbps.

Installation

1. Connect the UTP cable to your router.
2. Make sure the charging station is turned off (de-energised) at the local installation.
3. Connect the UTP cable with the port on the bottom of the charging station (7) on page 2).
4. Connect the charging station as described in paragraph 3.4 and then turn on the power supply on the local installation.
5. In order for your charging station to communicate with ICU EZ via an UTP Ethernet connection, it may be necessary to change your network settings if these are additionally secured. The necessary information to obtain access through your network is:
 - IP address ICU EZ: 93.191.128.6
 - Port: 9090
 - FTP port: 21
 - Inbound - outbound

It might be necessary to add a MAC address. You can find this in the Network Settings tab in the Service Installer application.

REMARK

Make sure your network settings allow connection to the Alfen servers through a secured FTP connection. This enables software updates and the exchange of diagnostics.

5.3 Register your ICU EZ account

If you want to enter into a contract for ICU EZ management services with Alfen, visit: www.alfen.com/en/services/management-charging-stations to register.

REMARK

You can only register as a user once you purchased the ICU EZ charging station. In order to register, you will need the information for your first charging station. We use this information to identify you. As soon as your account has been set up, Alfen will send you with login details. Did you forget to register, but you have already ordered the ICU EZ? No problem. If you ordered the charging station configured for ICU EZ, your charging station is already registered and active in the management system. All transactions and other actions from the past are saved and visible to you.

1. Complete the registration form on the Alfen website.
2. In the 'remarks' field, enter the numbers located on the back of your charge passes.
3. Click 'Send'.
4. Alfen will process your request and activate your account. After which you will receive an notification of your new account in ICU Connect (EZ).
5. Following the link in the verification mail, you are requested to provide you password. Make sure it is a strong and password.
6. Set your privacy preferences allowing your data to be shared with operators that also have access to your station (this can be for example your distributor or installer for additional services).
7. With these login details, you will be able to log in to the website www.alfen.com/en/more/login.
8. After logging in on ICU EZ, you will be able to access your charging point and its status immediately.

5.4 Managing settings

If your charging station is connected to a management system, it is possible to manage settings remotely even without using the Service Installer application. Alfen charging stations offer a myriad of configuration possibilities, for everything from basic settings to advanced smart charge settings.

These fall broadly into the following categories:

- General information, such as the present charging current and temperature
- General settings for the charging station like language, intensity of the status indications and load capacity
- Switching between RFID and Plug & Charge and
- Settings for transaction messages
- Smart charge settings
- Connectivity
- Smart Charging Network
- Overview of activated options (see paragraph 2.6) and possibility to change (license code)

Alfen innovates continuously. Settings are regularly added, extended, adjusted and removed. The latest version of all settings can always be found at:













www.alfen.com/en/downloads

5.5 Register your charging station to your own management system









When using a non-Alfen management system, it is essential that you register the charging station model. The Eve Single Pro-line FR model will send a ChargePointModel in accordance with OCPP specifications when logging in. The table in paragraph 2.6.1 indicates available options for the Eve Double Pro-line FR.

APPENDIX A: ERROR CODES AND PROBLEM-SOLVING

This appendix provides a description of, and advice related to, the error codes that can be generated by the Eve Double Pro-line FR charging station. If you are not able to find a working solution, please contact the seller of the charging station, or contact Alfen Support using the contact information displayed on the back of this manual.

Code	Alarm message text	Icon	Possible causes	Possible solutions
001	Not able to charge. Please call for support.		Generic Error.	Contact the service department of your charge point supplier.
Charge point error				
101	One moment please. Your charging session will resume shortly.		DC fault current (>6mA) detected by charging station.	One specific vehicle: Contact your car dealership. Multiple vehicles: Contact the service department of your charge point supplier.
102	Not able to charge. Please call for support.		Internal error.	Contact the service department of your charge point supplier.
104	Not able to charge. Please call for support.		Error internal voltage.	Contact the service department of your charge point supplier.
105	Check installation or call for support.		Internal error.	Contact the service department of your charge point supplier.
106	Not able to charge. Please call for support.		Power interrupted by internal 30mA AC residual current protection device.	Contact your installation engineer.
Installation error				
201	Error in installation. Please check installation or call for support.		Protective earth not connected or unstable.	Contact your installation engineer.
202	Input voltage too low, not able to charge. Please call your installer.		Supply voltage below 210 VAC.	Contact your installation engineer.
206	Temporary set to unavailable. Contact CPO or try again later.		Charging station is set to inoperative by the Charge Point Operator.	Contact your charge point operator.
211	Not able to lock cable. Please call for support.		Unable to move lock motor during start-up.	Contact your installation engineer.
212	Error in installation. Please check installation or call for support.		Missing phase in installation.	Contact your installation engineer.
Vehicle error				
301	One moment please your charging session will resume shortly.		Generic error.	<ul style="list-style-type: none"> • Check car and charging cable. • Otherwise contact the service department of your charge point supplier.
302	One moment please your charging session will resume shortly.		Vehicle draws more current than allowed / did not respond in time to reduce charging speed.	One specific vehicle: Contact your car dealership. Multiple vehicles: Contact the service department of your charge point supplier.

APPENDIX A: ERROR CODES AND PROBLEM-SOLVING

Code	Alarm message text	Icon	Possible causes	Possible solutions
Vehicle error				
303	One moment please your charging session will resume shortly.		Safety measure, charging is started too often within 1 minute.	<ul style="list-style-type: none"> • Check car and charging cable. • Otherwise contact the service department of your charge point supplier.
304	Charging not started yet to continue please reconnect cable.		Cable connected for more than 2 minutes without starting a charging session.	<ul style="list-style-type: none"> • Reconnect cable. • Otherwise contact the service department of your charge point supplier.
External factors error				
401	Inside temperature high. Charging will resume shortly.		Temperature inside the charge point above 70 degrees Celsius.	<p>Unexpected</p> <ul style="list-style-type: none"> • Ambient temperature. • No EV charging <p>Contact the service department of your charge point supplier.</p> <hr/> <p>Expected:</p> <ul style="list-style-type: none"> • Ambient temperature. • Installed in direct sunlight. • EV charging. <p>Contact your installation engineer.</p>
402	Inside temperature low. Charging will resume shortly.		Temperature inside the charge point below -40 degrees Celsius.	<p>Unexpected</p> <ul style="list-style-type: none"> • Ambient temperature. <p>Contact the service department of your charge point supplier.</p> <hr/> <p>Expected:</p> <ul style="list-style-type: none"> • Ambient temperature.
403	Charging not started yet to continue please reconnect cable.		Generic error.	Contact the service department of your charge point supplier.
404	Not able to lock cable. Please reconnect cable.		Unable to lock the charging cable.	<ul style="list-style-type: none"> • Check socket and charging cable plug. • Otherwise contact the service department of your charge point supplier.
405	Cable not supported. Please try connecting your cable again.		Check charging cable (PP value out of range according to IEC norm values)	<p>One specific cable Issues with other charge points</p> <p>Cable broken.</p> <hr/> <p>All cables. No issues with other charge points.</p> <p>Contact the service department of your charge point supplier.</p>
406	No communication with vehicle Please check your charging cable		Check charging cable (CP value out of range according to IEC norm values)	<p>One specific cable Issues with other charge points.</p> <p>Cable broken.</p> <hr/> <p>All cables. No issues with other charge points.</p> <p>Contact the service department of your charge point supplier.</p>

APPENDIX B: DEFAULT SELECTIONS FOR OPTIONAL FACTORY SETTINGS

The Eve Double Pro-line FR charging station has the following Smart Charge options:

1. Active load balancing: this offers the same functionality for managing charging speeds as the default load balancing in double charging stations. Managing the maximum charging current now, however, is a dynamic process. The charging station communicates with the smart meter in your installation or home and takes the current usage and maximal capacity of your grid connection into account.
2. Smart Charging Network (SCN): When activated, Alfen charging stations will recognise each other within a local network, a so-called charging plaza. In that case, the local grid settings are shared between the charging stations. Together, the charging stations decide how much power each outlet - provided a vehicle is connected - will be allocated. To simplify the order process of smart charge functionalities, a number of parameters have been provided with default settings. This appendix provides the values of these settings. If your installation needs different settings from these defaults, use the Service Installer to configure the charging station for your specific situation.

B.1. Active load balancing

Requirements for the installation:

- Alfen charging stations with activated Active Load balancing functionality.
- Communication cable with 4-wire RJ11/RJ12 connectors.
- Smart meter supporting one of the following protocols:
 - DSMR or eSMR over a P1 port. See paragraph 2.6.5. for the supported versions of this protocol.
 - Modbus TCP/IP: the charging station will assume the role of the Modbus Master in this configuration. The smart meter is the Slave.
- The charging station is also able to communicate with a customer's Energy Management System (EMS).
 - The communication protocol Modbus over TCP/IP is used to transfer data from the EMS to the charging station.
 - In this case the charging station acts as a 'slave' and the EMS as a 'master'.



NOTICE!

Alfen recommends a maximum cable length of 20 metres, combined with the P1 port. Always check if the communication with the smart meter is working properly. The quality of the signals depend on several factors. Therefore, always limit the cable length to prevent risks concerning the signal. Alfen ICU B.V. is not liable for continuous and correct operation of the connection to the P1 meter and the quality of the transferred signals.

The charging station and the smart meter communicate via the P1 port. For this, the DSMR protocol is used (for supported versions, see paragraph 2.6.5). Periodically, information on current usage is exchanged. When the meter capacity is reached, the charging station will adjust the connected vehicle. This prevents the installation from overloading, otherwise the cost of the grid connection will unnecessarily go up. This functionality effectively makes for 'peak shaving', it controls the power supply during peak moments.

If the P1 port of the smart meter is already occupied by another device, you can use a splitter. For advice on splitters, please contact your dealer.



NOTICE!

Not all splitters can be used. 2-wire connectors cannot be used. In that case, your charging station might not be able to communicate with the smart meter. Alfen is not liable for continuous and correct operation of the connection to the P1 meter if this has multiple devices and/or splitters attached.

To set up the active load balancing correctly, set the following parameters:

- Station-maxCurrent; This limits the maximum current on the charging station group.
- SmartMeter-maxCurrent; This is the capacity of your grid connection. When in doubt, check this with your grid operator.
- Load balancing safe current (A): the value of the current that remains available for the charging station (or charging plaza) when the connection between the energy meter and the charging station is lost.

APPENDIX B: DEFAULT SELECTIONS FOR OPTIONAL FACTORY SETTINGS

Modbus TCP/IP settings

In order for smooth communication with the smart meter through the Modbus TCP/IP, both need to be installed in the same network. Before reading out all necessary data fields, the smart meter and the charging station need to be able to communicate. For that, the following settings are important:

- Port: 502
- IPv4 addresses (use fixed IP address), assigned by the network operator
- Modbus address of the energy meter
- Default gateway of the local network
- Subnet mask of the local network

Factory settings	Options	Values
SCN-NetworkName	Name of the SCN	Maximum of 8 characters
SCN-SocketID	Unique ID of a socket within an SCN. For a charging station with two sockets, this identification represents socket 1.	0-255
SCN-SocketCount	The total amount of sockets in the SCN.	Maximum 100
SCN-AlternatingPeriod	The alternating period used in the event of insufficient capacity. This characteristic is automatically synchronised between charging stations within an SCN.	Maximum 65535 (seconds) Default: 360
SCN-TotalStaticCurrent	The maximum available capacity available for the SCN in amperes. This characteristic is automatically synchronised between charging stations within an SCN.	Default 200 A
SCN-SocketSafeCurrent	This safety value is used as a fall-back in case a charging station loses connection with the other stations. This characteristic is automatically syn-chronised between charging stations within an SCN.	Default 6.0 A
SCN-PhaseMapping-1	Single feeder cable on the left Socket: This characteristic shows how the charging station is connected to the installation (phase shifts). Attention! With double feeder cable: use SCN-Phasemapping-2.	Default: 4 1 = L1, 2 = L2, 3 = L3, 4 = L1L2L3, 5 = L1L3L2, 6 = L2L1L3, 7 = L2L3L1, 8 = L3L1L2, 9 = L3L2L1 Other values are invalid.
SCN-PhaseMapping-2	For single feeder cable on the Right Socket: This characteristic shows how the charging station is connected to the installation (phase shifts)	Default: 4 1 = L1, 2 = L2, 3 = L3, 4 = L1L2L3, 5 = L1L3L2, 6 = L2L1L3, 7 = L2L3L1, 8 = L3L1L2, 9 = L3L2L1 Other values are invalid.
SCN-TotalSafeCurrent	Used as a fall-back in case multiple charging stations loose connection with the other stations. The total number of active charging stations will be limited not to exceed the SCN-TotalSafeCurrent. This characteristic is automatically synchronised between charging stations within an SCN.	Default 32.0 A

APPENDIX B: DEFAULT SELECTIONS FOR OPTIONAL FACTORY SETTINGS

The table below provides an overview of values that can be read. Because the charging stations adjust to the currents per phase (bold in the table), this is the minimal information necessary to operate the active load balancing.

Measured value	Step size	Data type
Voltage L1L2 [V]	0.01 [V]	UNSIGNED32
Voltage L2L3 [V]	0.01 [V]	UNSIGNED32
Voltage L3L1 [V]	0.01 [V]	UNSIGNED32
Voltage L1N [V]	0.01 [V]	UNSIGNED32
Voltage L2N [V]	0.01 [V]	UNSIGNED32
Voltage L3N [V]	0.01 [V]	UNSIGNED32
Frequency [Hz]	0.001 [Hz]	UNSIGNED32
Current L1 [A]	0.001 [A]	UNSIGNED32
Current L2 [A]	0.001 [A]	UNSIGNED32
Current L3 [A]	0.001 [A]	UNSIGNED32
Current N [A]	0.001 [A]	UNSIGNED32
Active Power Sum [W]	0.1 [W]	SIGNED32
Reactive Power Sum [VAr]	0.1 [VAr]	SIGNED32
Apparent Power Sum [VA]	0.1 [VA]	UNSIGNED32
Cos(phi) Sum []	0.001 []	SIGNED32
Active Power L1 [W]	0.1 [W]	SIGNED32
Active Power L2 [W]	0.1 [W]	SIGNED32
Active Power L3 [W]	0.1 [W]	SIGNED32
Reactive Power L1 [VAr]	0.1 [VAr]	SIGNED32
Reactive Power L2 [VAr]	0.1 [VAr]	SIGNED32
Reactive Power L3 [VAr]	0.1 [VAr]	SIGNED32
Apparent Power L1 [VA]	0.1 [VA]	UNSIGNED32
Apparent Power L2 [VA]	0.1 [VA]	UNSIGNED32
Apparent Power L3 [VA]	0.1 [VA]	UNSIGNED32
Cos(phi) L1 []	0.001 []	SIGNED32
Cos(phi) L2 []	0.001 []	SIGNED32
Cos(phi) L3 []	0.001 []	SIGNED32

B.2 Smart Charging Network

The Smart Charging Network (SCN) is the smart charging functionality that makes connected Alfen charging stations form a single charging plaza. For every outlet used, the individual stations in the network decide how fast they can charge, taking the total load into account. To achieve this, all connected charging stations exchange data on the current charging capacity for all users.

APPENDIX B: DEFAULT SELECTIONS FOR OPTIONAL FACTORY SETTINGS

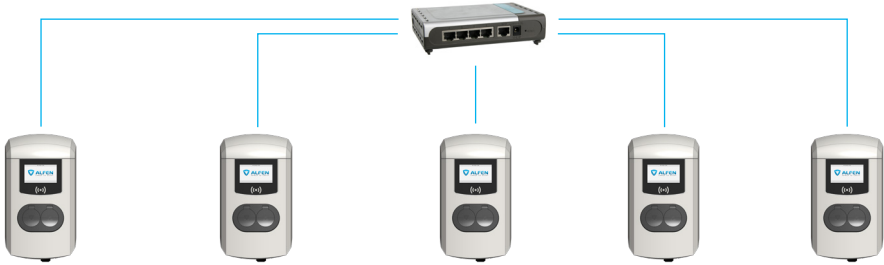

Image 10: Smart Charging Network with Eve Double Pro-line FR models

To ensure the correct operation of an SCN, it is important that all settings are correctly configured. As soon as the communication for the charging stations is installed, the charging plaza will at least have the following settings:

- Total capacity for all charging stations combined.
- Maximum charging current per outlet: this is determined by the group in the local installation and the maximum charging current of the charging station.
- Minimum charging current per outlet; This setting is:
 - a security setting; when a charging station loses its network connection, all charging stations will use this setting. The charging station that lost connection will continue to charge on this minimal charging current while the other charging stations reserve this small reserve capacity, and will temporarily not utilize this.
 - Minimum speed as a preferred setting; as soon as an extra outlet is used for charging and the remaining capacity is not enough to supply the minimum, the outlets used will alternate; one will charge while the other pauses, in 15 minute intervals.
- Alternation period (pause) in the event of insufficient capacity; by default, this is 15 minutes. The administrator can change this, if desired.

Preconditions for a properly functioning Smart Charging Network:

- All charging stations are in the same network (subnet, IP range) By default, this is 169.254.x.x.
- CAT5 UTP/Ethernet cable (minimal), CAT6 for cable runs over 100m.
- Minimum 10Mbps network
- UDP port: 36549, inbound-outbound.
- Use the DHCP server, if possible.
- Without a DHCP server, the charging stations obtain an IP address via Auto-IP.
- All charging stations are fed from the same point, there is no layered electricity grid.

- An (existing) switch or router with a sufficient amount of connection points is available to connect all charging stations together.
 - Daisy chaining from charging station to charging station is not possible.
 - Tip: Always make sure one port is available to connect a laptop with the Service Installer application. Otherwise, make sure the laptop is in the same subnet as the charging stations.

REMARK

If network components like a switch or router are to be installed outdoors, we strongly advise purchasing the components accordingly and installing them in a suitable installation cabinet.

Adding a charging station to the Smart Charging Network

With the Service Installer application, all charging stations in the Smart Charging Network will be set up at the same time. All charging stations within the same subnet will be identified by the Service Installer application.

You can initialise the Smart Charging Network from the Service Installer. Select the charging station, navigate through the 'Device' menu to 'Add to new SCN'. Next, follow these steps:

- Name your SCN (charging plaza).
- Next, click on another charging station and click '+'. The charging station will be added to the desired SCN. The charging station will assume the network settings.
- Repeat step 2 until all charging stations are added to the SCN.

APPENDIX B: DEFAULT SELECTIONS FOR OPTIONAL FACTORY SETTINGS

If the functionality was purchased. The charging station will not be part of the SCN if you have not purchased this functionality. After you receive confirmation for your purchase of this functionality by Alfen, the new functionality can be downloaded using the Service Installer application.

 **NOTICE!**

After setting up a Smart Charging Network, all newly added charging stations will need to reboot. After rebooting, the charging stations will log in to the Smart Charging Network.

About OCPP

The functionalities of the SCN are available through the UTP/Ethernet connection of the charging stations. This can easily be combined with communication over OCPP, through UTP/Ethernet or GPRS. Note that you need one SIM card per charging station. To limit costs, you can also use a router and a (2G/3G/4G) modem. In that case, the charging stations should be set to communicate with a wired network. The router is then set for the (secure) APN of the relevant management system.

How to set up

Network choice	Per charging station	OCPP settings
Smart Charging Network with OCPP GPRS	SCN ON	OCPP Management System Selection for GPRS
Smart Charging Network with OCPP GPRS	SCN ON	OCPP Management System selection for UTP
Smart Charging Network with OCPP through external GPRS router	SCN ON	OCPP Management System selection for UTP
Electrical supply (local installation)	See paragraphs 2.6.9 and 2.6.10, always set to full power per charging station.	
Settings	Factory settings: set for charging station (max output)	

REMARK

Want to know more about the Smart Charging Network? Contact our Sales department or Sales Support via cpadmin@alfen.com

Electrical and electronic equipment (EEE) contains materials, components and substances that may be hazardous and present a risk to human health and the environment when waste electrical and electronic equipment (WEEE) is not handled correctly.

Equipment marked with the below crossed-out wheeled bin is electrical and electronic equipment.

The crossed-out wheeled bin symbol indicates that waste electrical and electronic equipment should not be discarded together with unseparated household waste, but must be collected separately.

For this purpose all local authorities have established collection schemes under which residents can dispose waste electrical and electronic equipment at a recycling centre or other collection points, or WEEE will be collected directly from households. More detailed information is available from the technical administration of the relevant local authority.

Users of electrical and electronic equipment must not discard WEEE together with household waste. Residents must use the municipal collection schemes to reduce adverse environmental impacts in connection with disposal of waste electrical and electronic equipment and to increase opportunities for reuse, recycling and recovery of waste electrical and electronic equipment.



Contact

Alfen ICU B.V.

Hefbrugweg 28
NL-1332 AP Almere
Pays-Bas

Boîte postale 1042
NL-1300 BA Almere
Pays-Bas

Tél. Sales Support: +31 (0)36 54 93 402

Tél. SAV : +31 (0)36 54 93 401

Site Web : www.alfen.com/en/ev-charge-points
www.alfen.com/fr/bornes-de-charge-ev